



ESBG 2015

EUROPEAN STRAWBALE GATHERING MONTARGIS | PARIS



THE RESULT OF MONITORING IN FRANCE



Sensors from Behrens & Krause

The concept

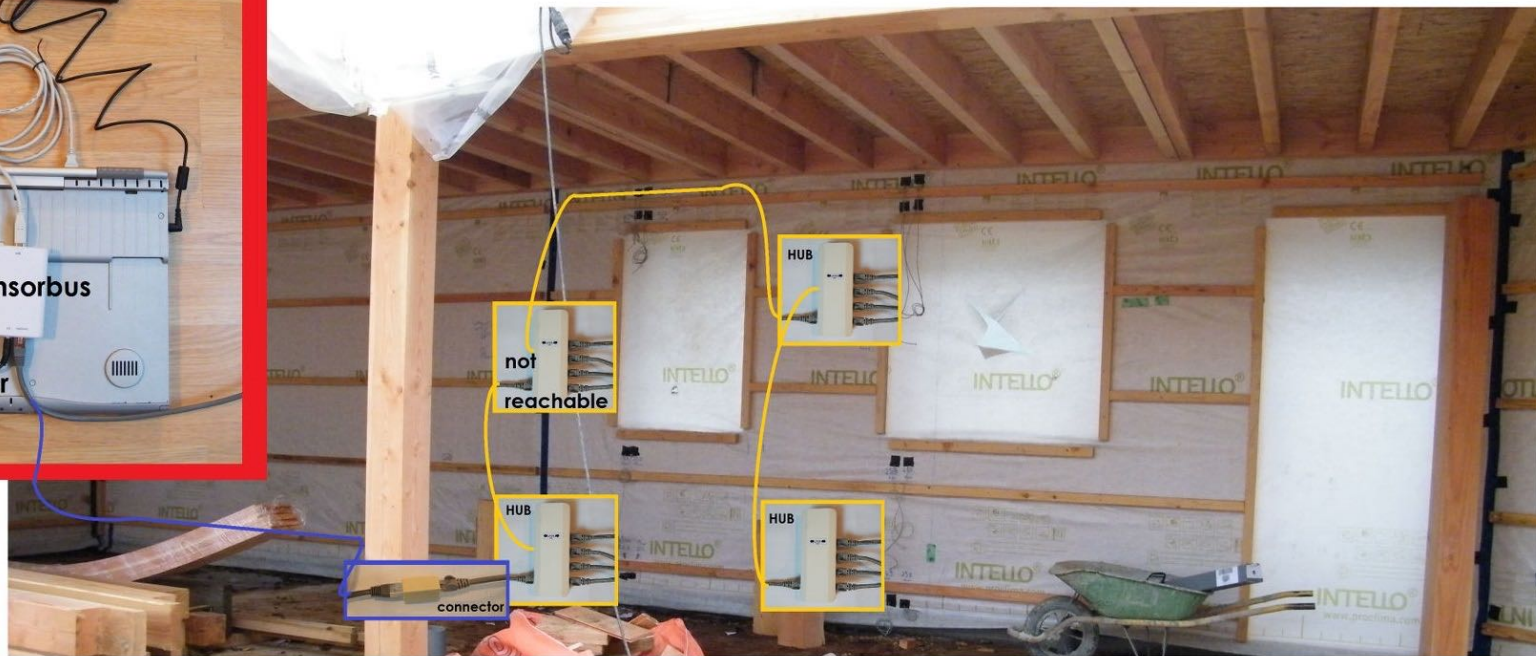
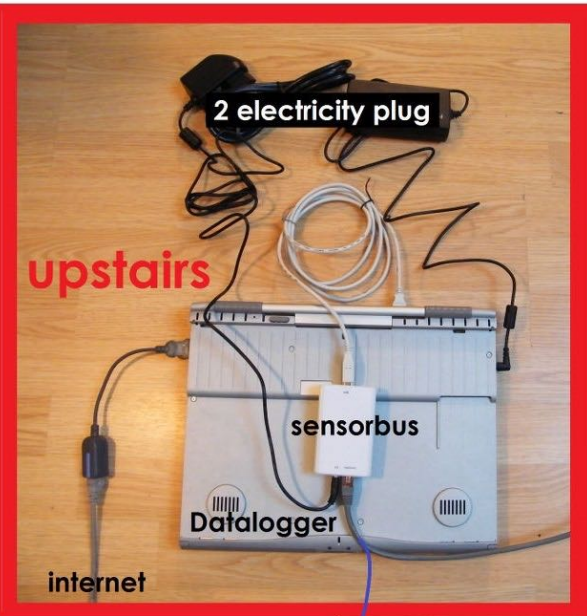

2 instrumented walls
2 instrumented building

8 sensors by wall

an internet connection to recover data

Sensors from Behrens & Krause

House in Morancé (69) near Lyon



Architect : Stéphane Peignier
Straw compagny : Batinature

Sensors from Behrens & Krause

House in Morancé (69) near Lyon

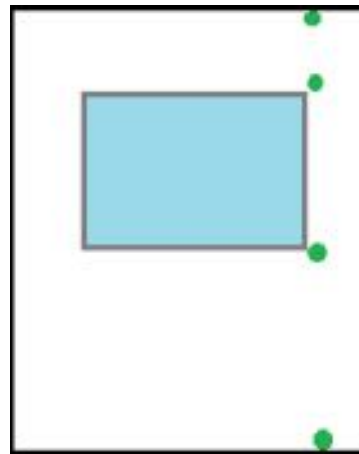

16 sensors
(relative humidity
and temperature)

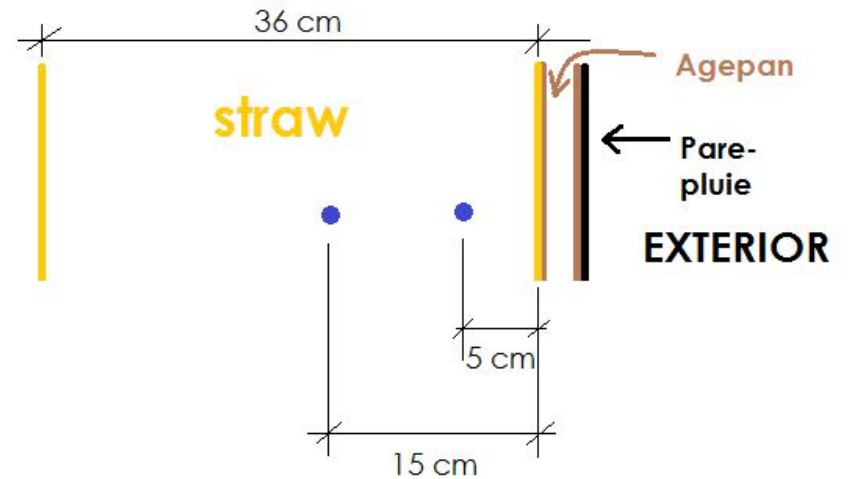

Sensors from Behrens & Krause

A nursery in Muel (Bretagne)



Architect : Stéphane Peignier
Straw compagny : Batinature

Sensors from Behrens & Krause

A nursery in Muel (Bretagne)

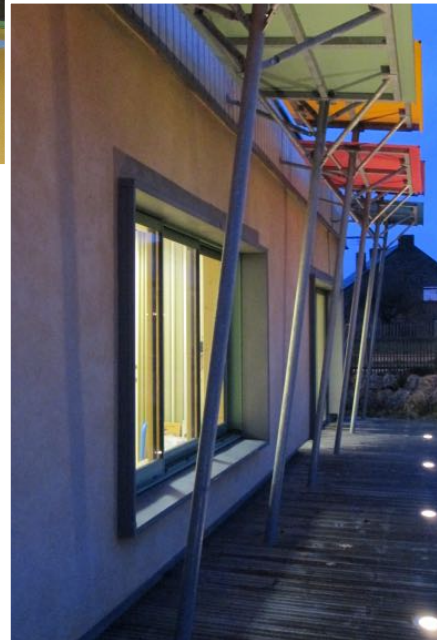
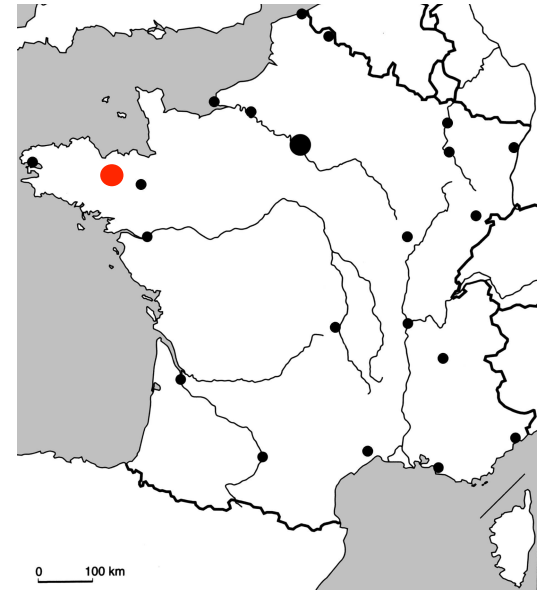

Sensors from Behrens & Krause



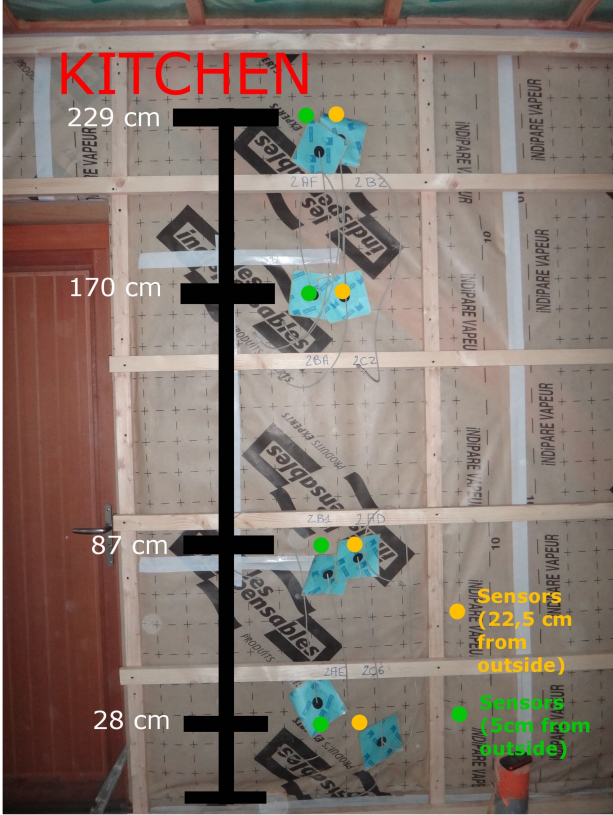
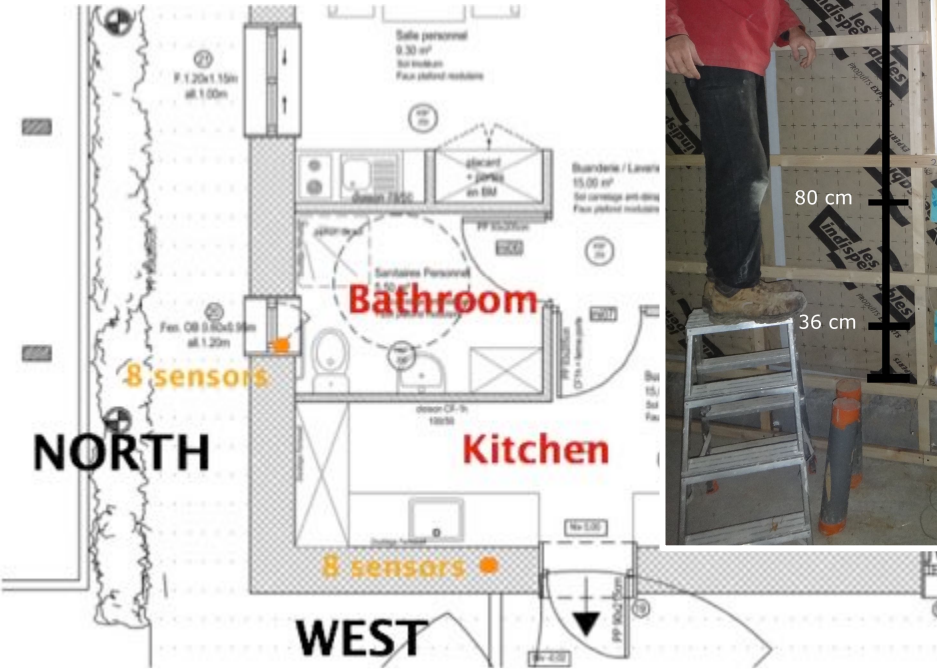







A nursery in Muel (Bretagne)



Sensors from Behrens & Krause

Results

data

project	Morancé
measuring point	bain cuisine Allege_15 Allege_5 Linteau_15 Linteau_5
time interval	* * * *
type	t->temp / rel. humidity
	line <input checked="" type="checkbox"/> usercolors
resolution	standard
actions	     
legend	 Morancé .bain.Allege_15@all  Morancé .bain.Allege_5@all  Morancé .bain.Linteau_15@all  Morancé .bain.Linteau_5@all

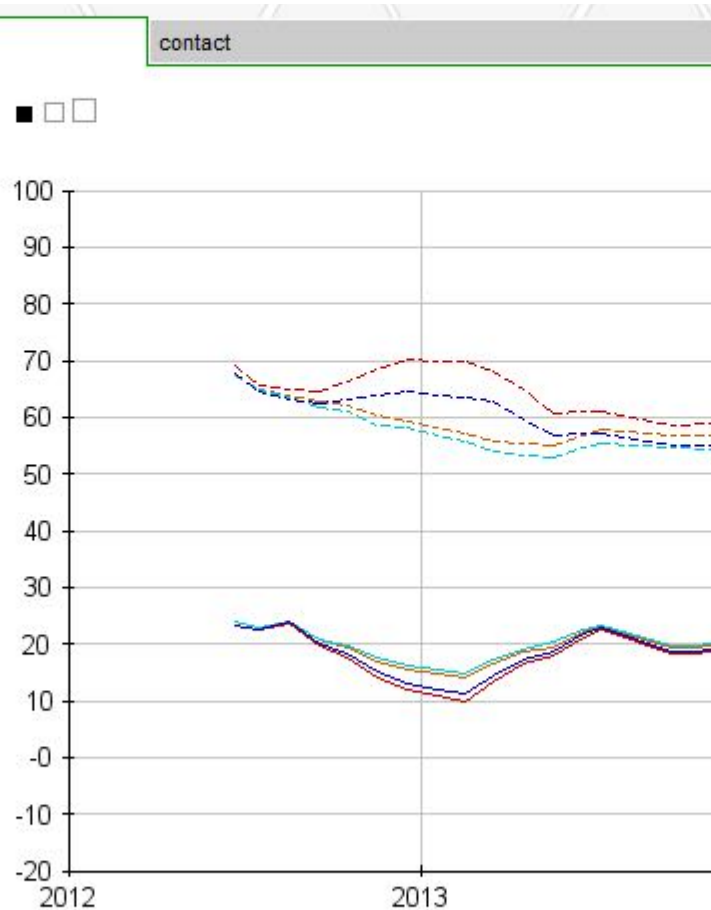

Sensors from Behrens & Krause

Analysis - Software

Acquisition

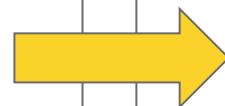
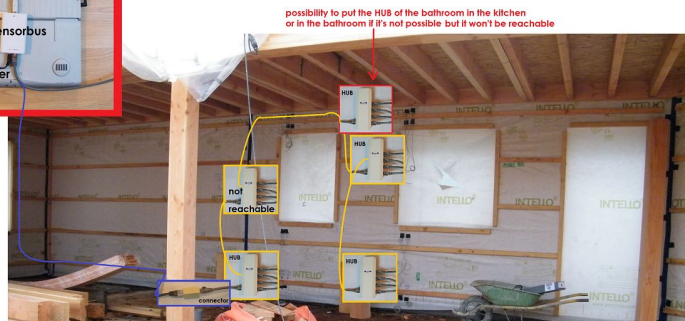
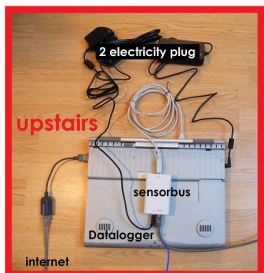

Data storage format



Excel

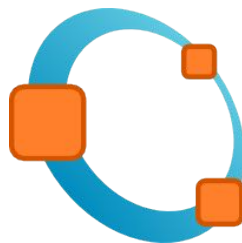
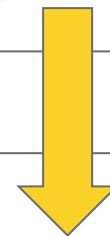

Data processing with Octave

Sensors from Behrens & Krause

Analysis - Concept

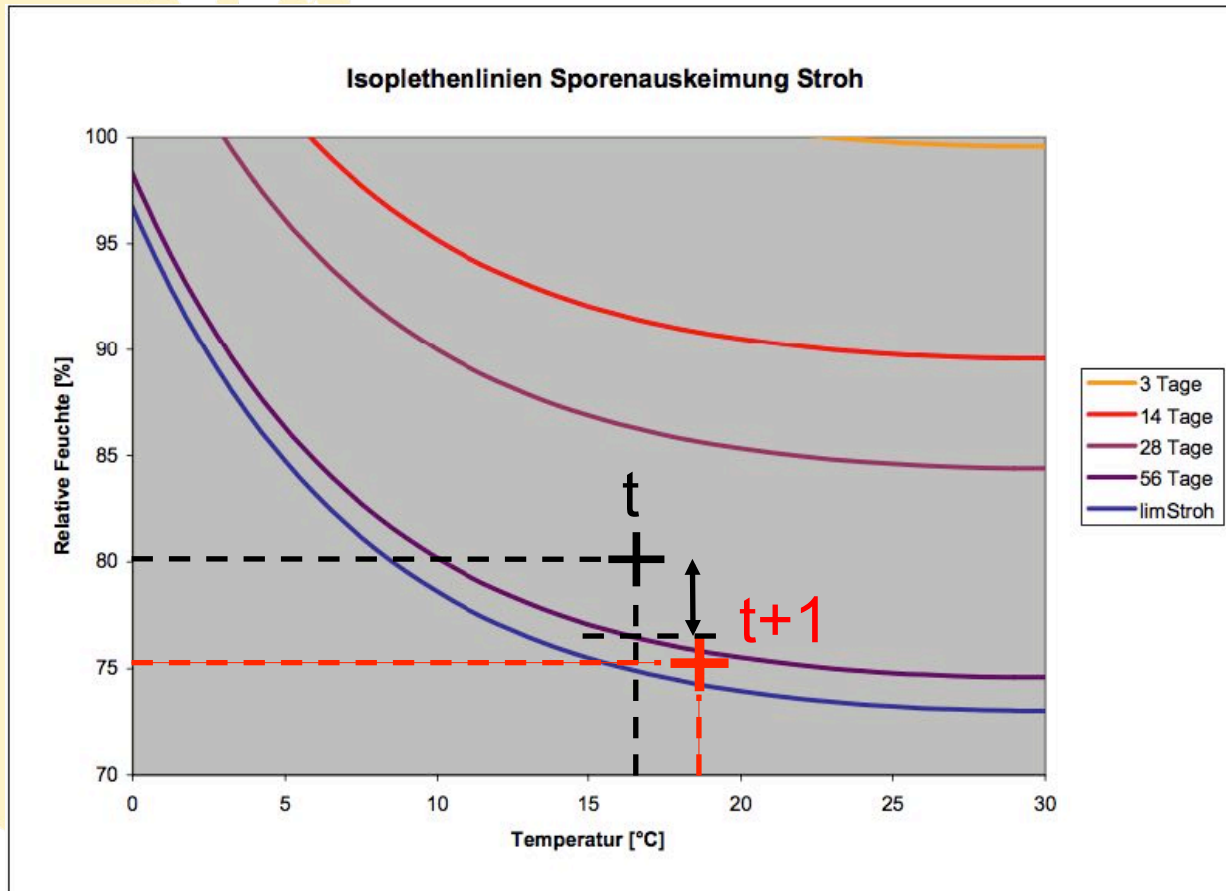

Quelle: Fa. IBO GmbH.

Processing :

- Plot paires (T ; RH)
- Point-to-point comparison between points and curves
- Comparison between the episode duration and the limit time of curves

Sensors from Behrens & Krause

Analysis - Outputs

Diagramme des points Sdb

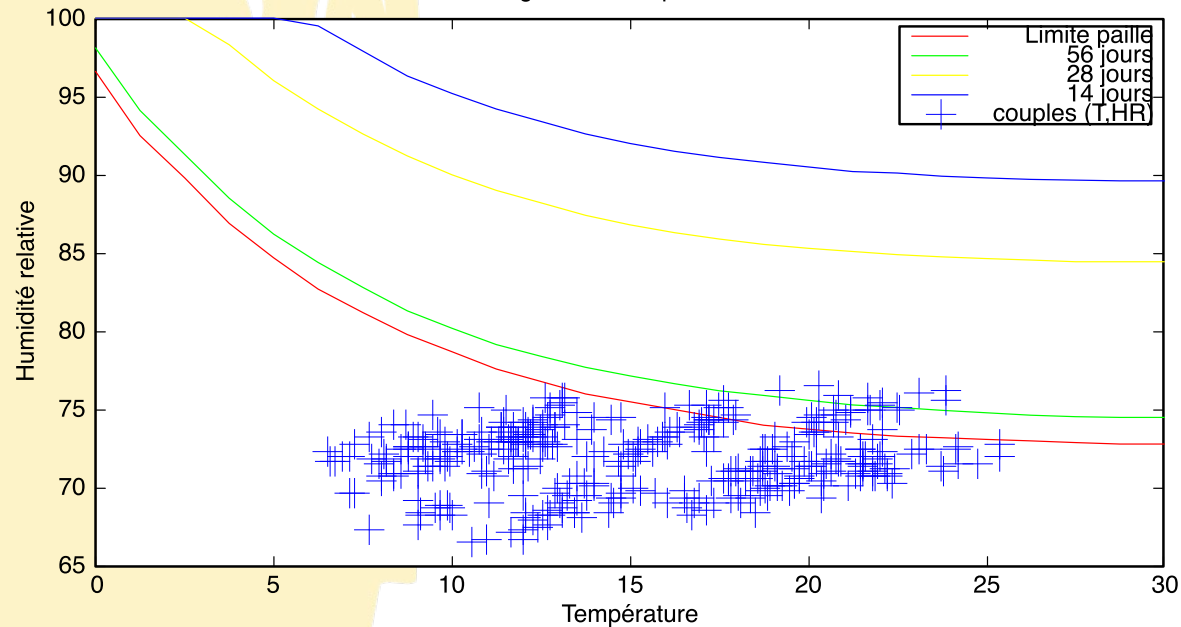

Potential mould growth

Start date	Duration
...	...
...	...